

28" x 22½" ADA Reversible Shower Seat with legs, Phenolic Solid

MODEL: APFSLR2-280225PWS (WHITE)
APFSLR2-280225PTS (TEAK)



DIMENSIONS:

28" x 22 1/2"

HEIGHT ADJUSTABLE BETWEEN:

17" - 19"

WEIGHT CAPACITY:

900lbs

FEATURES:

- Durable phenolic solid seat top
- Four legs, hinged to fold up
- Stainless steel frame, with front access mounting flanges
- Supports up to 900lbs when properly installed
- Seat color options: White and Teak. (Specify when ordering)



Built in USA



1 Year Seat Warranty

CODE COMPLIANCE:

- ADA 610.4 Structural Strength
- ADA 309.4 Operation

28" x 22½" ADA Reversible Shower Seat with legs, Phenolic Solid

MODEL: APFSLR2-280225PWS (WHITE)
APFSLR2-280225PTS (TEAK)

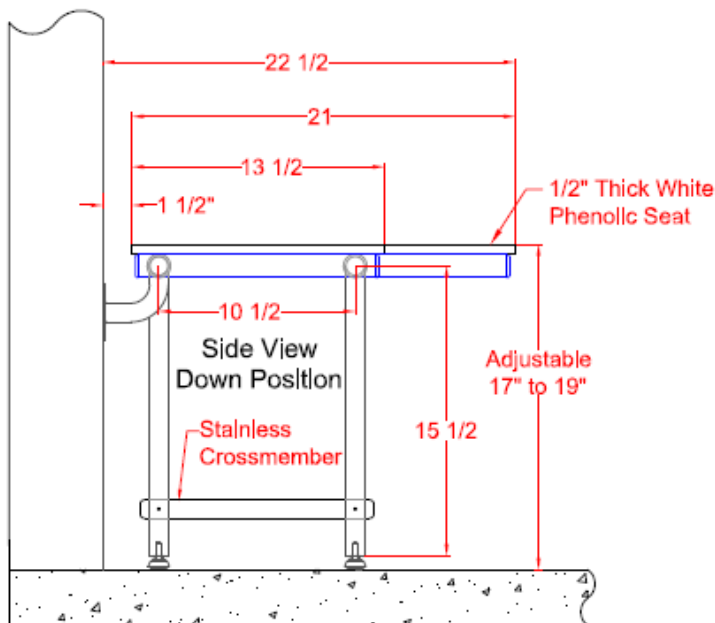
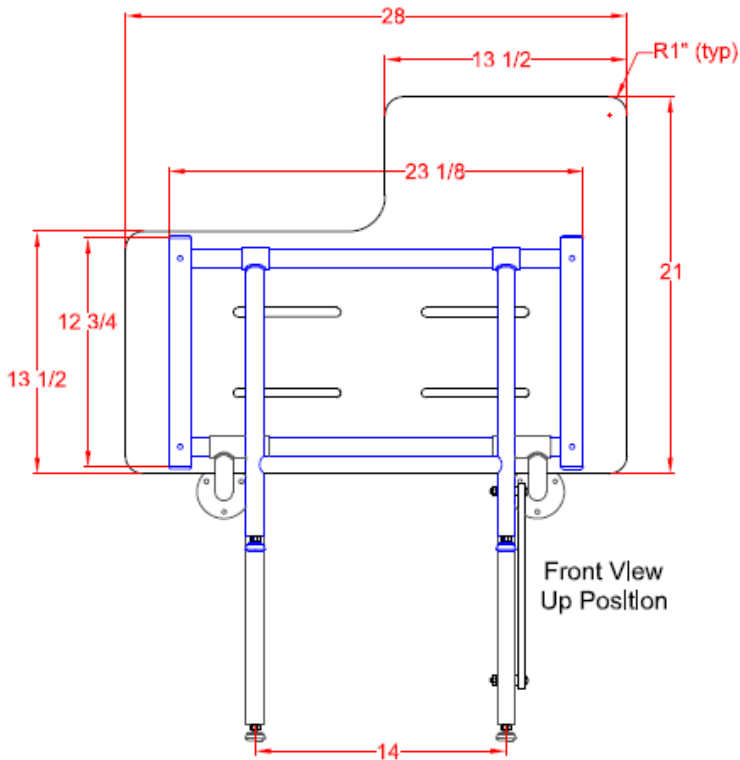

ARCHITECTURAL SPECIFICATIONS:

MATERIALS:

FRAME: Type 304 (18-8) S.S. tubing, 1-1/4" (32mm) x 18ga. (1.2mm) sq. main frame with 1" (25mm) x 18ga. (1.2mm) rd. cross members.

WALL FLANGES (2): Type 304 (18-8) S.S., 10ga. (3.4mm) x 3" (76mm) Dia. Heliarc welded to 1" (25mm) rd. x 18ga. (1.2mm) 90 degree leg supports, and to 1-1/4" (32mm) rd. x 12ga. (2.7mm) frame hinge couplings. Three mounting holes in each flange.

SWING DOWN LEG: "H" Shaped yoke of type 304 (18-8) S.S. 1" Dia. (25mm) x 18ga. (1.2mm) rd. tubing, heliarc welded to 1-1/4" (32mm) rd. x 12ga. (2.7mm) frame hinge couplings.

SEAT TOP

PWS, or PTS - White (PW) or Teak (PT)

Phenolic 1/2" (13mm) One Piece Solid secured to frame with S.S. screws.

OPERATION:

The swing down legs automatically level when the seat is lowered to a horizontal sitting position. The seat automatically locks itself when swung into its "up" position with the use of the stainless cross member.

INSTALLATION:

All Shower Seats must only be installed using suitable fasteners and sufficient in-wall backing materials. A.D.A. mounting height for lowered seat is 17" (432mm) to 19" (482mm).