

# Freedom ADA Roll-in Shower 63" x 32" Center Drain, Multi-Piece

MODEL: APC6332BF4PC



Made in USA



30-Year Warranty

## EXTERIOR DIMENSIONS:

63" x 32 1/2" x 79 3/4"

## INSIDE DIMENSIONS:

60" x 30"

## FEATURES:

- ADA & Title 24 Compliant (Chapter 11A & 11B)
- 4-piece shower for remodeling
- 3/4" threshold with pre-leveled and reinforced shower base for easy installation
- Center drain location
- Individual accessories and ADA packages available
- Fiberglass construction
- Durable, easy-to-clean applied gel coat
- Textured slip resistant floor
- Fully reinforced walls that offers strength and ease of installation for accessories
- **Installation Note:** Shower installs directly on level subfloor. Finish flooring up to threshold as shown in detail

## ACCESSORY PACKAGES AVAILABLE:

ADA Accessory Package includes:

- Reversible, L-shaped folding shower seat
- Grab bars x 3
- Soap dish, stainless

## INDIVIDUAL ACCESSORIES AVAILABLE:

- Reversible, L-shaped folding shower seat
- Grab bars
- Soap dish, stainless
- Collapsible water retainer with end cap
- Weighted shower curtain and rod
- Drain and stainless steel strainer
- Adjustable handheld shower kit with bar and ADA pressure-balanced shower valve

ADA compliant with correct ADAAG accessory installation

# Freedom ADA Roll-in Shower 63" x 32" Center Drain, Multi-Piece

MODEL: APC6332BF4PC

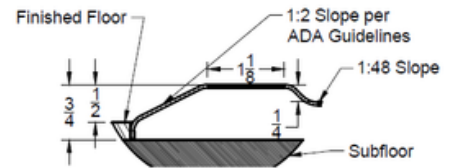
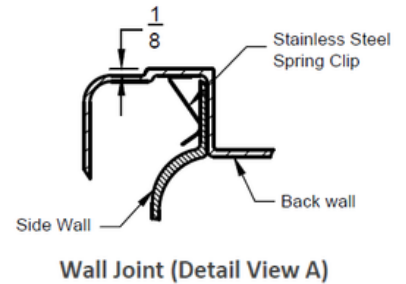
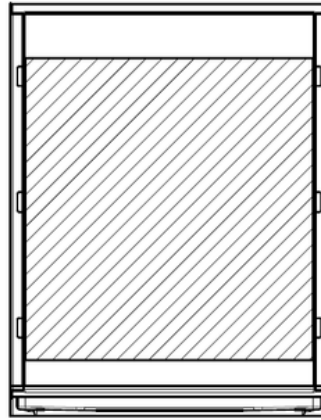
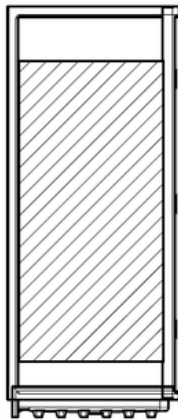
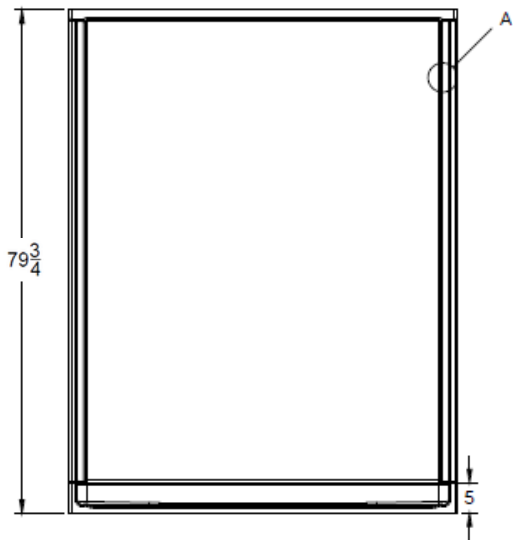

Shower installs directly on level subfloor

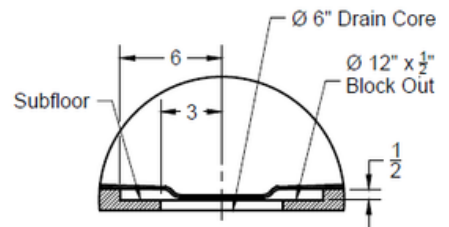
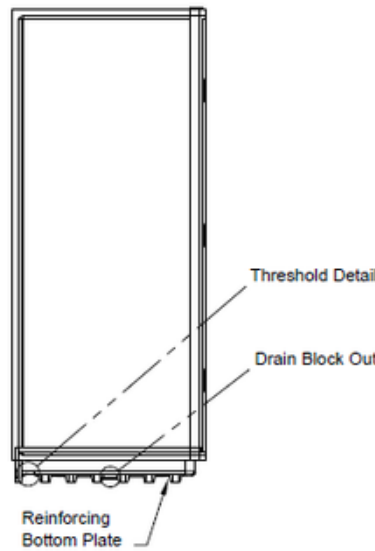
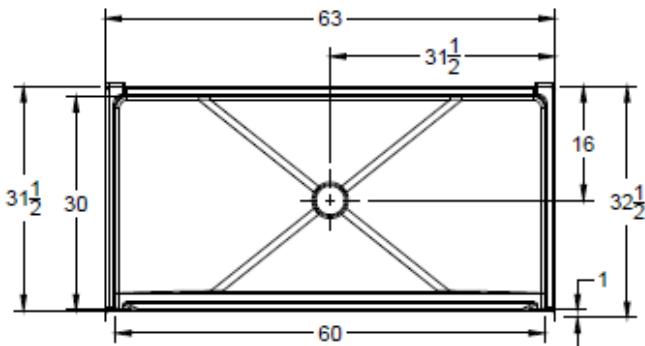

## NOTES:

Dimensional Tolerance  $\pm 1/2"$ .  
Accessibility Professionals Inc. assumes no responsibility for prep work

## CODE COMPLIANCE:

- ADA
- California Title 24 (Chapter 11A & 11B)
- HUD / FHA
- ICC A117.1 - 2017 ANSI Type A
- CSA B45.5-11 / IAPMO Z124-2017
- UPC Uniform Plumbing Code

## FRAME-IN DIMENSIONS:

|   |          |
|---|----------|
| A | 63 1/8"  |
| B | 32 1/2"  |
| C | 31 9/16" |
| D | 16"      |

