

Freedom ADA Roll-in Shower 63" x 36" Rear, Center Drain

MODEL: APC6336BF1P



Made in USA



30-Year Warranty

EXTERIOR DIMENSIONS:

63" x 36" x 78 1/2"

INSIDE DIMENSIONS:

60" x 33 1/4"

FEATURES:

- ADA & Title 24 Compliant (Chapter 11A & 11B)
- 3/4" threshold with pre-leveled and reinforced shower base for easy installation
- 1-piece for new construction
- Rear, center drain location
- Factory-installed ADA accessories available
- Fiberglass construction
- Durable, easy-to-clean applied gel coat
- Textured slip resistant floor
- Fully reinforced walls that offers strength and ease of installation for accessories
- **Installation Note:** Shower installs directly on level subfloor. Finish flooring up to threshold as shown in detail

ADA ACCESSORY PACKAGE AVAILABLE:

Factory-installed package includes:

- Fold-up L-shaped shower seat with legs
- 2 x Grab bars, Inside Corner and Straight
- Recessed soap dish
- Curtain rod
- Drain and stainless steel strainer

INDIVIDUAL ACCESSORIES AVAILABLE:

- Fold-up reversible shower bench
- Grab bars, straight and corner
- Adjustable handheld shower kit with bar
- ADA pressure-balanced shower valve
- Weighted shower curtain and rod
- Drain and stainless steel strainer

ADA compliant with correct ADAAG accessory installation

Freedom ADA Roll-in Shower 63" x 36" Rear, Center Drain

MODEL: APC6336BF1P

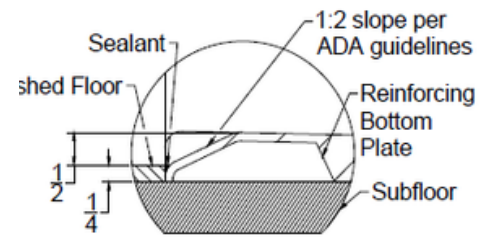
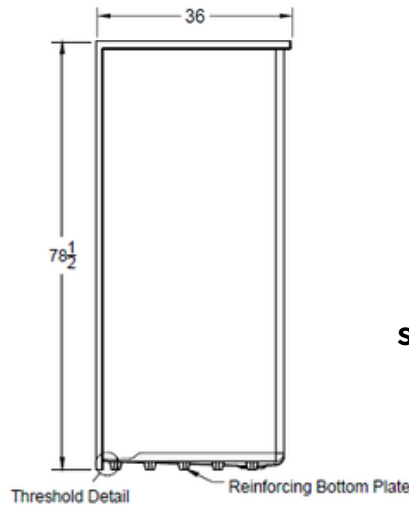
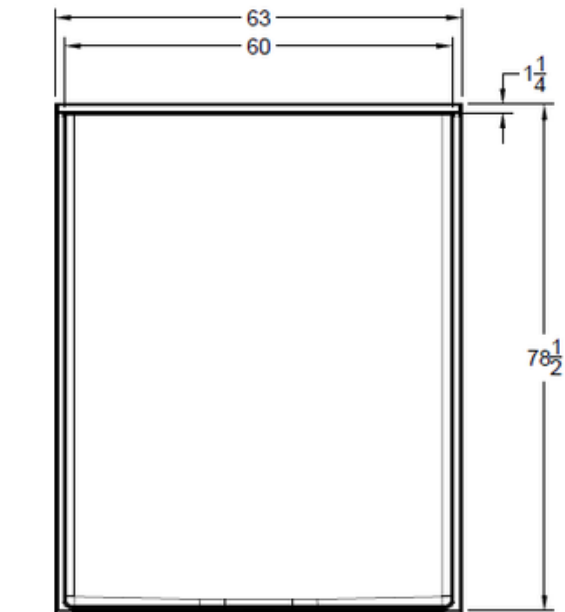

Threshold

Shower installs directly on level subfloor

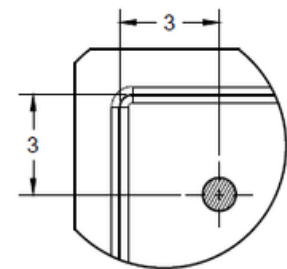
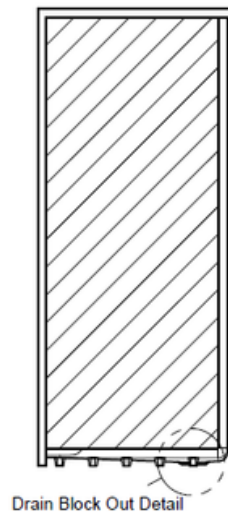
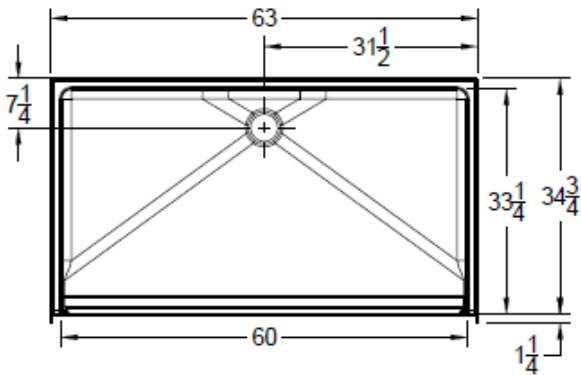

Standard Curtain Rod Location

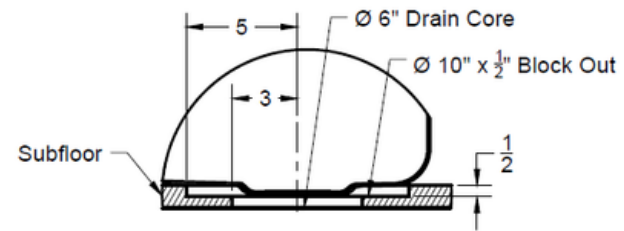

Drain Block-Out

NOTES:

Dimensional Tolerance $\pm 1/2"$.
Accessibility Professionals Inc. assumes no responsibility for prep work

CODE COMPLIANCE:

- ADA
- California Title 24 (Chapter 11A & 11B)
- HUD / FHA
- ICC A117.1 - 2017 ANSI Type A
- CSA B45.5-11 / IAPMO Z124-2017
- WAC 388-78A-3030
- UPC Uniform Plumbing Code

FRAME-IN DIMENSIONS:

A	63 1/8"
B	39"
C	31 9/16"
D	7 1/4"

