

# **FREEDOM**

BY ACCESSIBILITY  
PROFESSIONALS

## TRANSFER ACRYLIC WALK IN BATHTUBS INSTALLATION AND OWNERS MANUAL

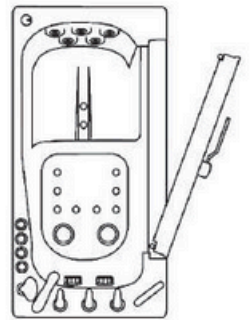
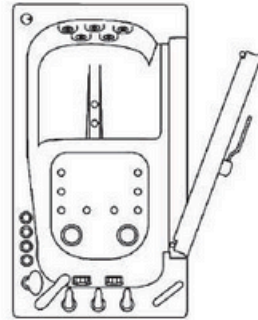
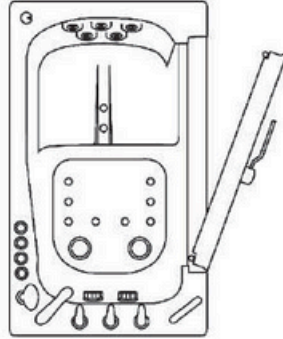
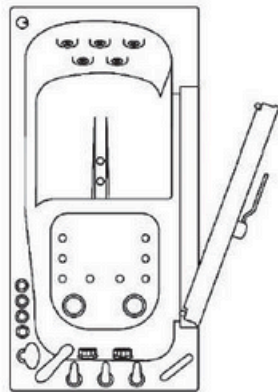
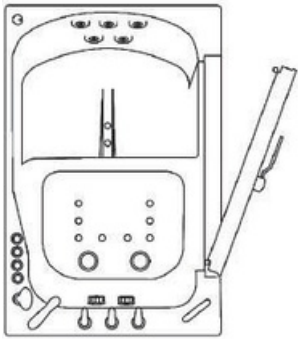

36"W x 55"L Seat  
Size: 29"W

30"W x 60"L  
Seat Size: 22"W

32"W x 52"L  
Seat Size: 24"W

30"W x 52"L  
Seat Size: 22"W

26"W x 52"L  
Seat Size: 19"W

**Customer Support: 1.877.947.7769**

**Email: [apsupport@accessibilityprofessionals.com](mailto:apsupport@accessibilityprofessionals.com)**



# Table of Contents

- Unpacking and Inspecting.....1
- Moving your Walk in Bath ..... 2
- Warnings and Labels.....3 - 5
- Important Safety Instructions..... 6 - 7
- Required Steps Prior to Installation..... 8
- 2" T-Type Dual Port Floor Drain..... 9
- Above the Floor Drain Installation..... 10
- Below the Floor Drain Installation Option..... 11
- Door and Frame Adjustments..... 12 - 14
- Service Access and Door Seal ..... 15
- Installation of Deck Mount Grab Bar..... 16
- Reversible Extension Kit..... 17
- Finishing the Installation of the Walk-In Bathtub to the Wall..... 18
- Operation Instructions ..... 19 - 24
- Cleaning and Maintenance ..... 25
- Warranty..... 26 - 28

## **IMPORTANT**

Warranty Activation Form **MUST** be completed for both the Owner and Installer to validate the warranty.

Failure to complete both pages will void the warranty on this bathtub.

**Completed Warranty Activation Forms can be emailed to [apsupport@accessibilitypro.com](mailto:apsupport@accessibilitypro.com) or mailed to 11 Victoria St Unit B3, Barrie ON L4N 3A3**

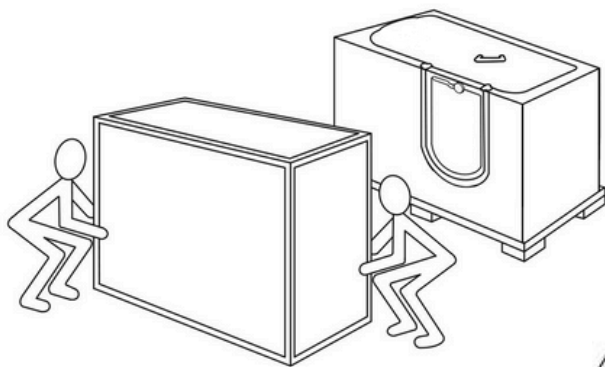
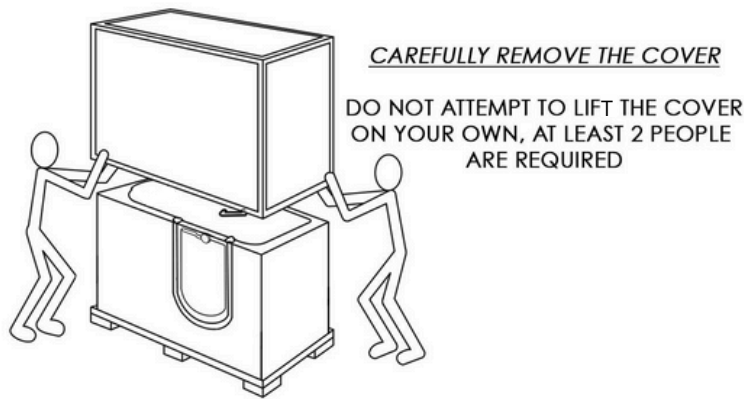
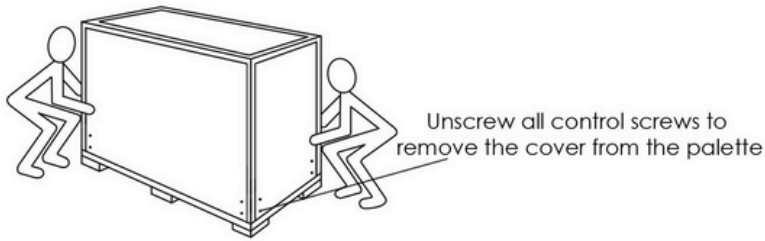

Upon receiving your walk-in bathtub, please inspect the crate and carton for any damages. If damages found, please take few pictures of damages with your phone and record the details on the shippers delivery document and ask the driver to sign it. If you think the product may be damaged, note that on the delivery document and call Freedom Showers. Damage must be recorded on shippers delivery documents for proper <sup>claim</sup> processing.

After inspecting the crate and accepting the product please unpack the crate as shown in images. When the product is unpacked please remove front apron with access panels and end panel before carrying into the house. By removing the apron and access panels you will be able to grab on to the frame to carry tub inside. Do not lift the bathtub by the plumbing or other parts. Avoid hitting the sides or the bottom not to break off the air jets or other parts of the bathtub. Inspect the plumbing or other parts that may have loosened in transit or by carrying the tub inside your home.

## **WARNING**

REMOVE END PANELS BEFORE ATTEMPTING TO MOVE OR CARRY. FAILURE TO DO SO CAN LEAD TO DAMAGING AIR JETS AND OTHER COMPONENTS OF THE BATHTUB.

Details on Page 5

# Moving your Freedom Walk in Bath

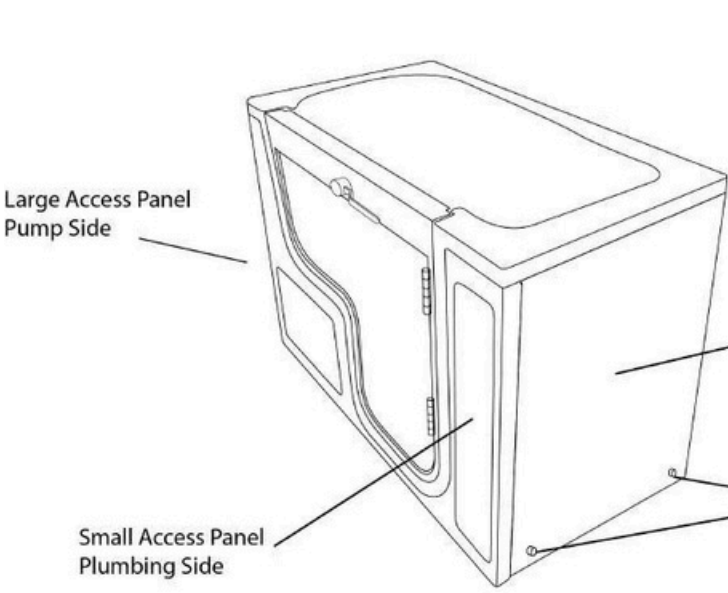

- Remove All 3 Panels Before Moving the Tub
- Take Off the Screw Caps
- Unscrew the Screws With a Philips Head Screw Driver
- Remove Access Panel



**WARNING:** Do not carry the walk in tub by the panels. Be careful when carrying the tub, avoid front panel contact with the floor or stairs to prevent damages. Make sure no loose parts are hanging down. Remove all four (3) access panels before carrying the tub to prevent them from falling out and breaking.

**WARNING:** Lift and carry the tub only by the frame. Protect the bottom of the tub to avoid breaking the air jets positioned on the bottom of the tub.

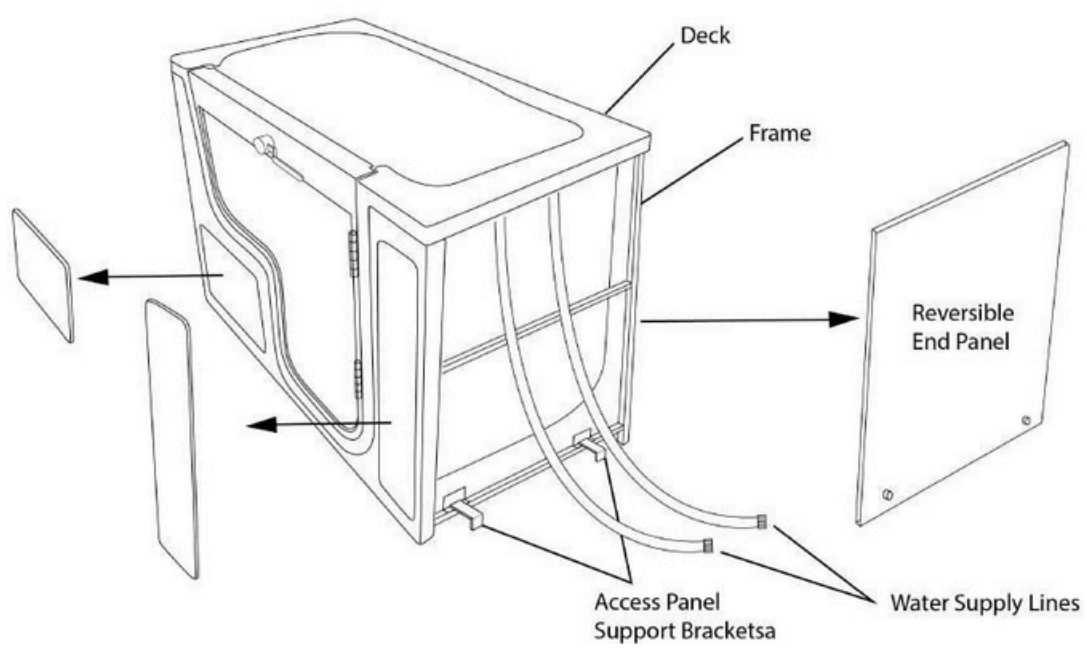

**You must follow all the instructions in this manual.**

FAILURE TO READ AND COMPLY WITH ALL INSTRUCTIONS CAN RESULT IN PRODUCT DAMAGE OR INJURY TO BOTH INSTALLER AND HOMEOWNER. IT WILL ALSO RESULT IN ASSUMPTION OF ALL LIABILITY BY SAID INSTALLER

**NOTE: NO RETURNS POLICY exception.**

Do not dispose of shipping material until the installation is complete. In the rare circumstance that an issue related to the fabrication of the Walk in Bath cannot be resolved in the field during installation, the manufacturer may request the Walk in Bath be returned. Returns are only accepted by the manufacturer in the original packaging used for shipping. Use caution so as not to damage cardboard crate or wooden pallet.

**WARNING**

GRAB BAR WASHERS MUST BE INSTALLED TO PREVENT CRACKING OF THE ACRYLIC SHELL  
WARRANTY IS VOID OTHERWISE

Details on Page 12

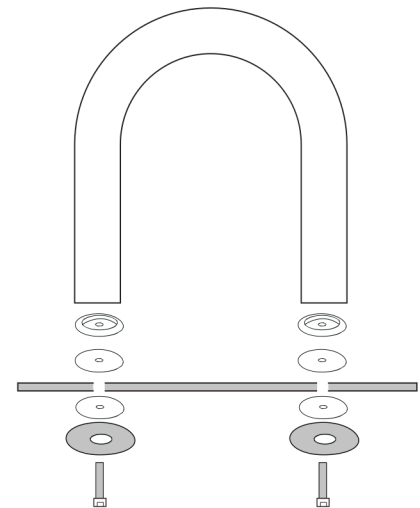

**WARNING**

MAKE SURE AIR PIPE CONNECTION TO PUSH CONTROLS IS PROPERLY TIGHTENED AND THAT PUSH CONTROLS ARE FUNCTIONING PROPERLY BEFORE FINALIZING INSTALLATION OF TUB

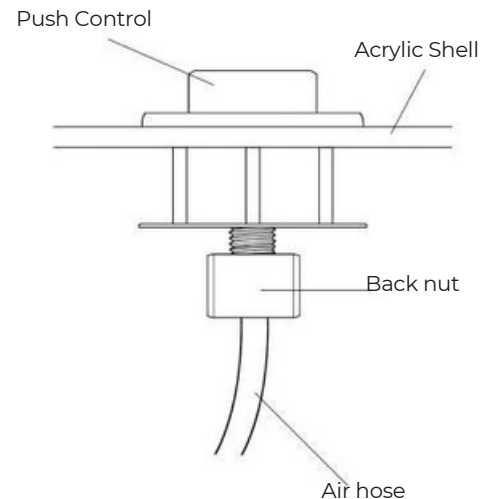

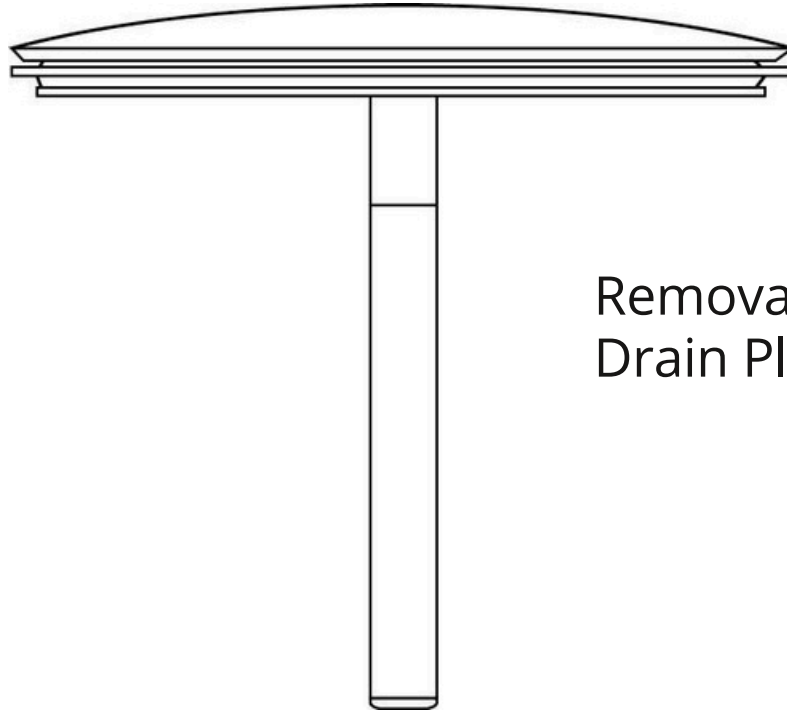

Removable  
Drain Plug

Drain open all the way



Drain closed completely



Drain must open completely to drain properly and close completely to avoid unnecessary drainage.

# WARNING!

## PLEASE READ BEFORE BEGINNING INSTALLATION

WARNING: Do not attach the hand held shower to the wall unless you have an extension hose with a barrel protection. This may cause water to leak behind your walk in tub.

### TO INSTALL BARREL EXTENSION HOSE:



Water from the hose can drip down into the hand shower base and get behind your tub without the barrel protection.



1) Start by unscrewing your shower head mixer from the hose.



2) Next take your stainless steel barrel and screw it on the end of the hose.

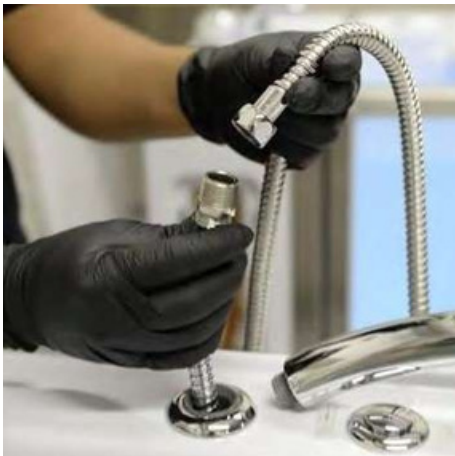

3) Take your extension hose and screw the end to the opposite side of the barrel.



4) Place the barrel in the shower base to plug the hole.



5) Finally, screw on the shower head mixer to the other end of the extension hose.

**WARNING:** Read through the entire manual completely before beginning installation.

Contract a licensed plumber and electrician for installation. Be sure you and your contractor are aware and follow all local plumbing and electrical codes. Your Walk in Bath is not intended for outdoor use. Install the tub in accordance with the instructions in the manual. Use ONLY the parts and accessories provided or as recommended by the Manufacturer.

**CAUTION:**

When using this product, basic precautions should always be followed. Read and follow all instructions pertaining to risk of fire, electric shock and injury. Make sure and have your licensed electrician test all connections to the dedicated line, including the GFCI. Risk of electric shock; Do not permit electric appliances within 3 feet (1.5m) of the tub. i.e.: hair dryers, lamps, phones, radios, televisions, etc. To reduce the risk of injury, do not permit children or persons with disabilities to use this product unless they are supervised by an able-bodied adult at all times. Never drop or insert any objects into any openings. Do not turn on the Hydro jets without water reaching the waterline. The waterline is the point where all jets are covered with water.

**DANGER:**

Temperature in excess of 100.4 Fahrenheit (38 Celsius) may be harmful to your health. Check and adjust the temperature before use. Consult your physician before using your Walk in Bath if you have a heart condition or other health issues. People using medications, herbal remedies, sleep aids, and/or having adverse medical history should consult a physician before using this product. Pregnant women should NOT use this product before consulting their physician. Avoid the use of alcohol, drugs or other medications while using your walk in bath. Be aware, hyperthermia is a risk when raising body temperature. Do not keep body submerged in heated bath for extended periods of time. The symptoms of hyperthermia include an increase in body temperature which can cause dizziness, lethargy, drowsiness and fainting. Avoid using the heated bath after strenuous activity.

*Exercise caution while entering and exiting your Walk in Bath.*

**WARNING: USE TUB ONLY AS INTENDED! FAILURE TO DO SO CAN LEAD TO INJURY OR DEATH**

CORRECT

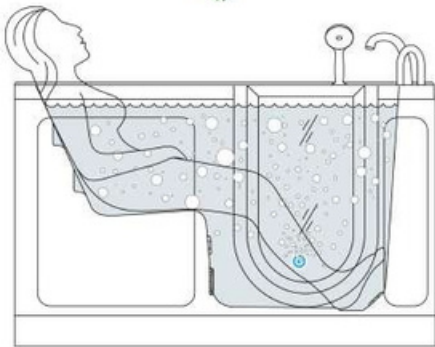

## **WARNING**

**BATHER SHOULD ONLY SIT AS SHOWN IN FIGURE TO THE LEFT. SIT FULLY IN SEAT WITH BACK ON THE BACKREST. DO NOT ATTEMPT TO SLOUCH OR LIE DOWN IN THE FOOT WELL AREA! DO NOT ATTEMPT TO PUT YOUR FEET UP ON OPPOSITE SIDE OF TUB!**  
In the case of bathers who do not have all functioning limbs or are paralyzed, bather must be attended by caregiver at all times and use an installed safety belt at all times.

## **WRONG POSITIONING**

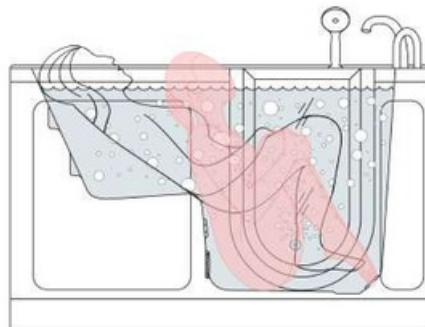
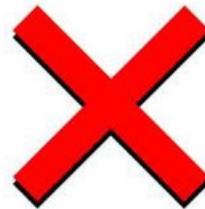
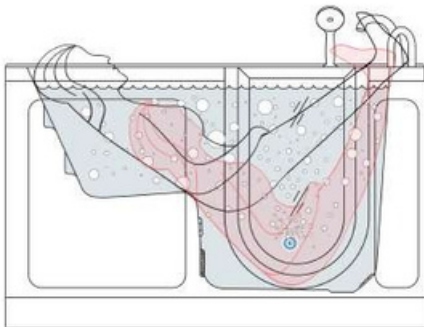



# Required Steps Prior to Installation

## Protecting the Bath

Cover and protect the bath shell and fixtures from scratches or other damages during the installation and tests. Remove the access panels when moving the Walk in Bath and always lift the bathtub from the frame.

## Electrical

The unit **MUST** be connected to a circuit protected by a ground fault circuit interrupter (GFCI) provided and installed by a licensed electrician and tested periodically (refer to instructions provided by GFCI manufacturer). Operating the pumps without first filling the bath to above the jets can cause permanent damage to your equipment. Push the GFCI "test" button into "reset" mode. If the GFCI fails to operate in this manner, there is a ground current flow or a device malfunction, indicating the possibility of electrical shock. If this occurs, turn OFF the power and do not use the bathtub until the source of the problem has been identified and corrected.

## Water Test

It is important to test that the Hydro and Air Pumps are functioning properly before final in-wall installation to avoid unnecessary repairs or removal.

- A.** Place the tub on a completely flat surface in an area where it may be drained after testing.
- B.** Using a clean rag and warm water wipe down seal to insure it is free of debris.
- C.** Seal the drains (this can be done with tape) and fill the tub to at least three inches above the highest jet, or to the bottom of the grab bar if no jets are present.
- D.** Allow the water to stand in tub for 30 minutes and then inspect all plumbing and seals for leaks.
- E.** Using appropriately rated three-prong extension cords, all plugged in to separate outlets, operate all electrical components (air blower, water pump, and heater if applicable) for another 30 minutes and inspect for leaks again. Inspect the unions around the pump and heater.
- F.** If a leak persists at a union after tightening, it may have been over-tightened or might have a displaced O-ring. Disassemble it and make sure the O-ring was seated properly. Do the same if a leak persists at the heater. Verify that the heater threads match the pipe threads.

# 2" T-Type Dual Port Floor Drain (Two Drains Included)

2" T-type Dual Port Floor Drain for  
Dual Drain Walk-In Bathtubs

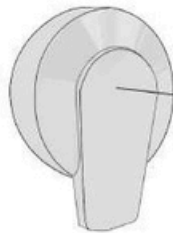

Drain opener with  
extended handle



Endcap installed on either side or not  
in case of both sides connected to  
the floor drain

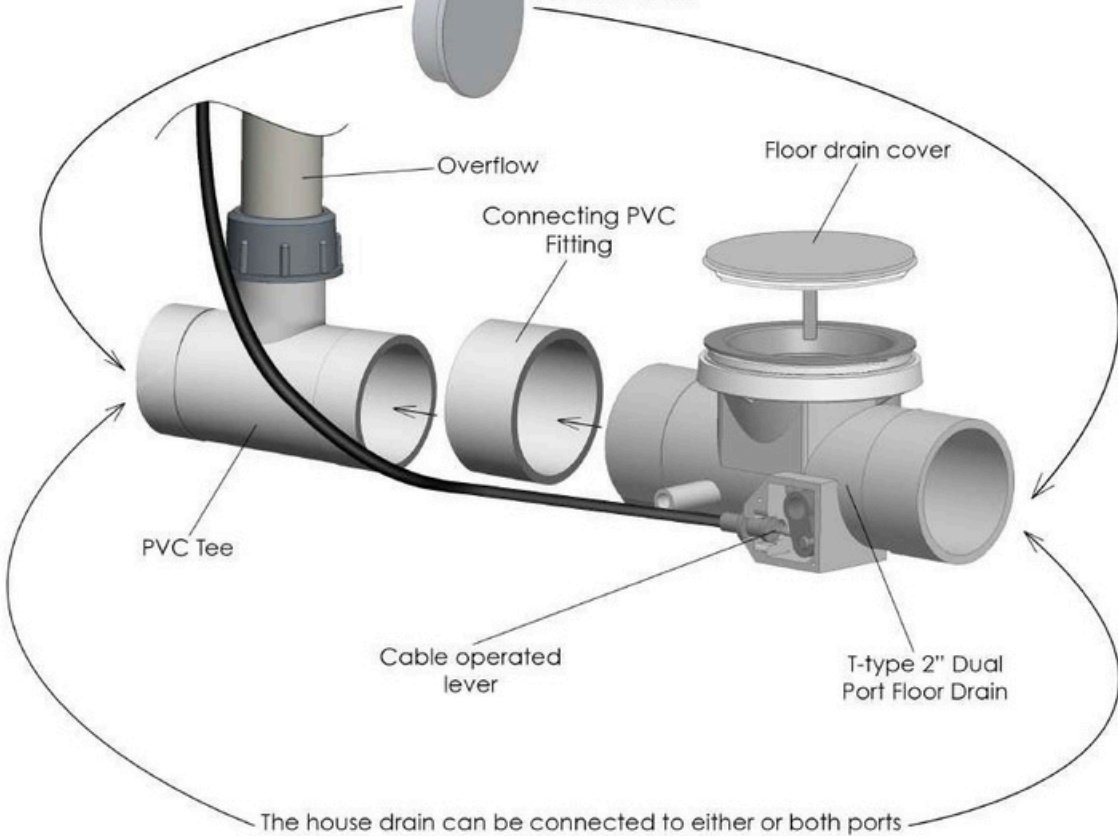

For best performance and faster drainage time, the 2" dual drain can be connected to all four 2" ports. Two (2) included caps can be used to cap off 2 unused ports if 2 ports selected to be connected to the house drain. The direction is optional and shown in image below. For best performance it is suggested to use Y vs T fitting to joint both 2" outlets and tap into the house drain. The less turns in drainage system the less resistance and faster drainage.

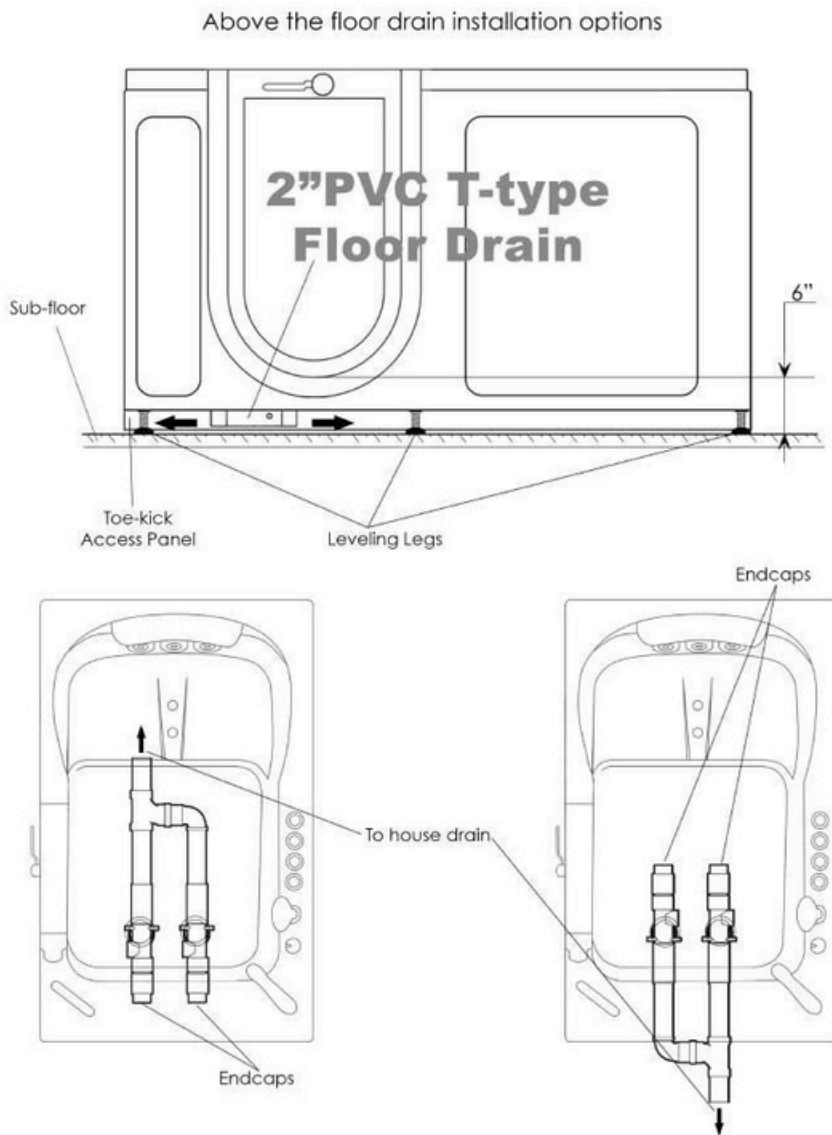

**Warning: make sure the house drains function properly before connecting the bathtub drain. Dual drain does not guarantee the fast drainage of the house drain if it's not functioning properly.**

## Recessing the Drain Below the Subfloor Level and Cutting the Apron and End Panel

The leveling legs allow for the tub be lowered, however, the bottom of the apron, end panel and the drain will hit the floor. It will be necessary to cut out access in the subfloor for the drain and cut the bottom of the apron and/or end panel (in case of a corner installation) for the tub be lowered. If cutting the bottom of the apron or end panel is needed, use masking tape and appropriate cutting tools to avoid damages to the acrylic panel.

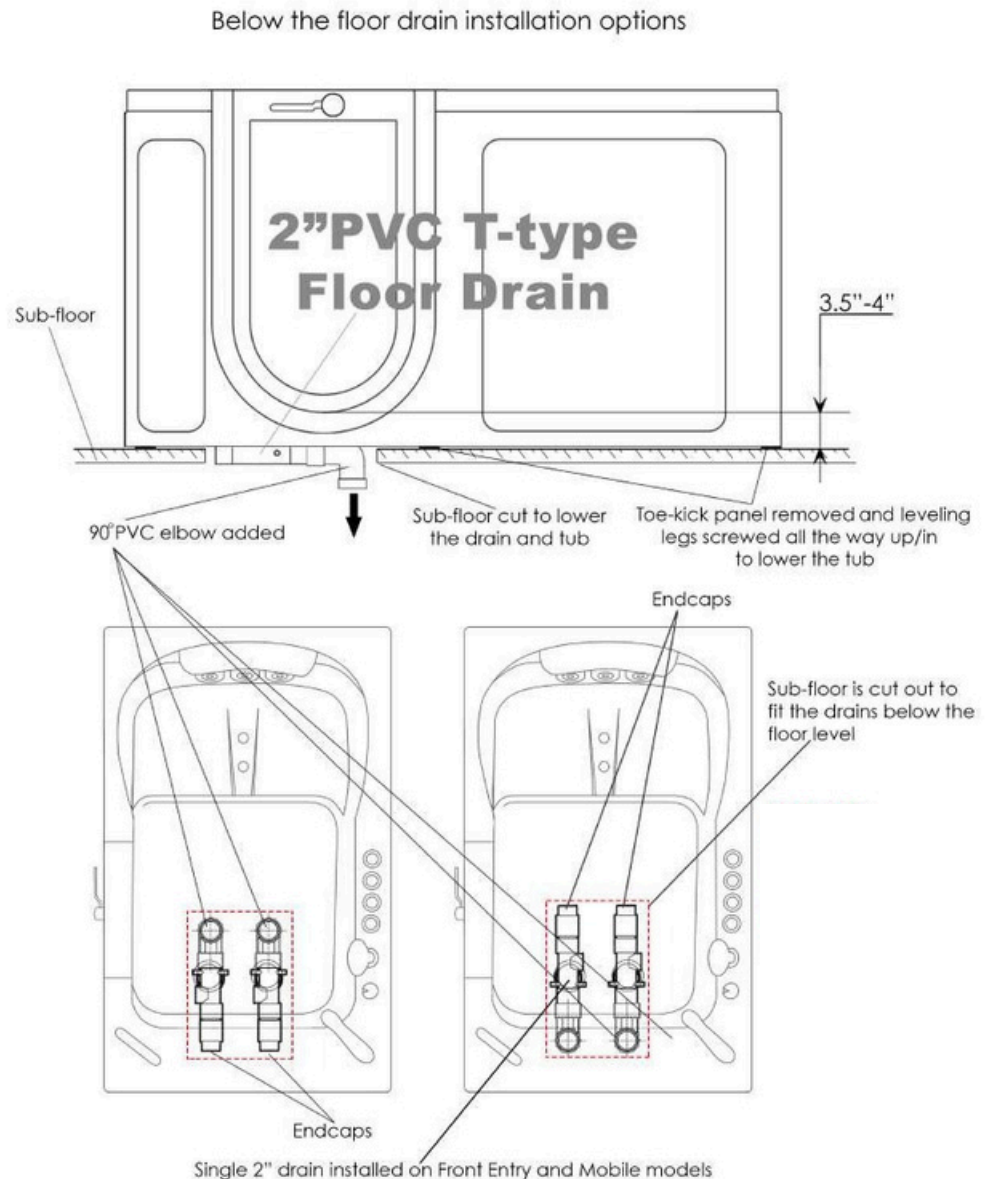

**Warning: If this custom installation is done, the warranty will not cover the damaged or altered parts of the bathtub.**

Prepare the sub-floor for the drain and ensure that the area is level. The supporting sub-floor must be able to support the total weight of the bathtub, bather and water and must meet local construction code requirements. Use a level and make sure that the sub-floor below the tub is leveled. If the floor is not perfectly level, adjust the appropriate leveling legs to re-align the tub to perfect level. It is important that all of the leveling legs are completely supporting the tub (touching the floor with equal weight distribution) and the tub is leveled for the door seal to work properly. If the tub is not perfectly leveled, it may cause frame and shell warping which can cause changes in door alignment resulting in water leakage and void the warranty.

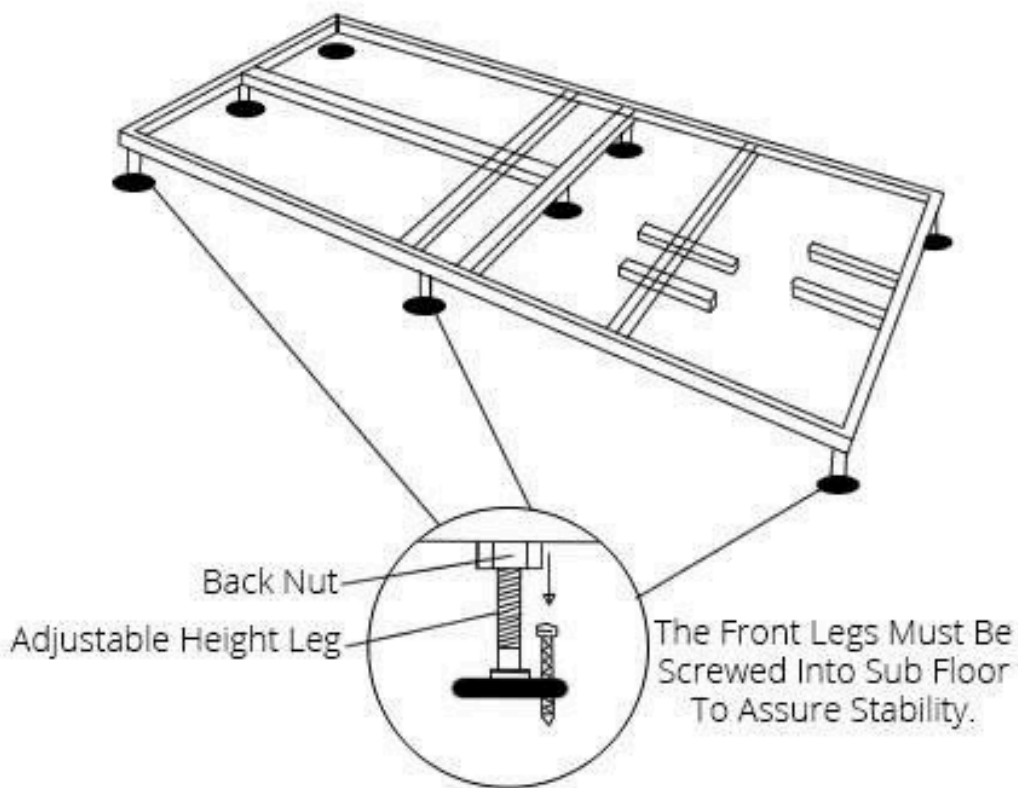

**DISCLAIMER:** The frame specifications and configuration vary based on model. If the sub-floor does not support the total weight of the bath, bather and the water, it can result in warping of the shell, misalignment of the door and/or create leaks and could lead to damage of your home.

Your walk in bathtub has been tested and leveled properly before leaving our facility. Our walk in bathtubs have been set on a perfectly level surface to ensure no leaks and proper door closing. It is up to your installer to test and make any adjustments necessary to ensure that all leveling legs support the tub frame and that the door is aligned correctly to prevent any leaks. The door must close smoothly to create a water tight seal.

Extending or shortening the legs will help correct any alignment issues to close the gap between the door and the frame. Please call us immediately if any issues arise or if you have any concerns. 1-877-947-7769.

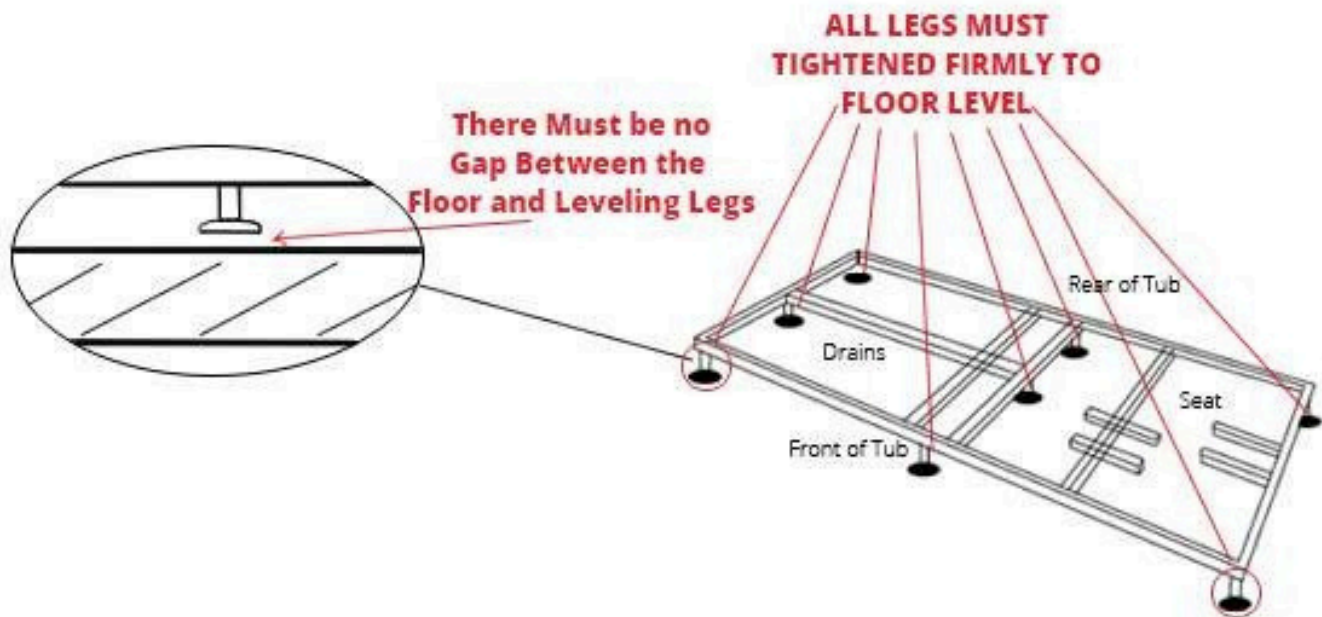

**DISCLAIMER:** The frame specifications and configuration vary based on model. If the sub- floor does not support the total weight of the bath, bather and the water, it can result in warping of the shell, misalignment of the door and/or create leaks and could lead to damage of your home.

**WARNING:** Failure to level the tub correctly WILL RESULT IN MISALIGNMENT! The drawings below illustrate some examples of what types of frame warping will occur if the legs are not level with the floor.

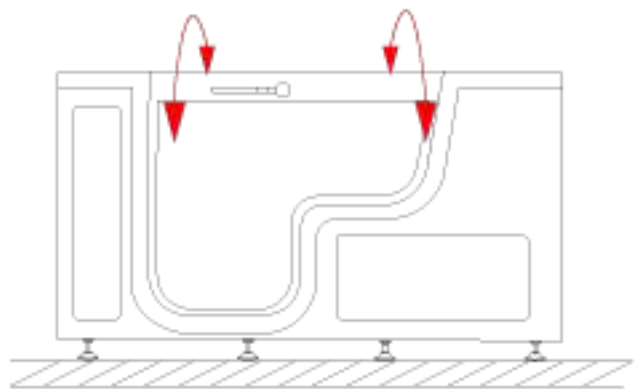
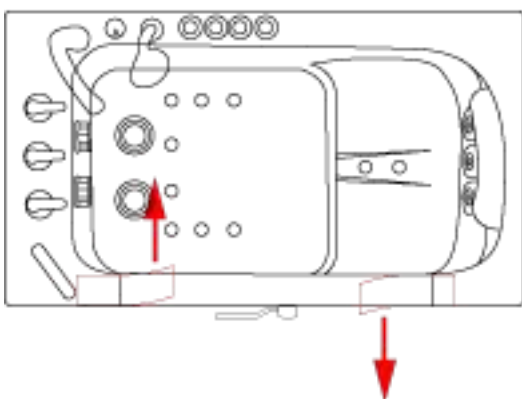
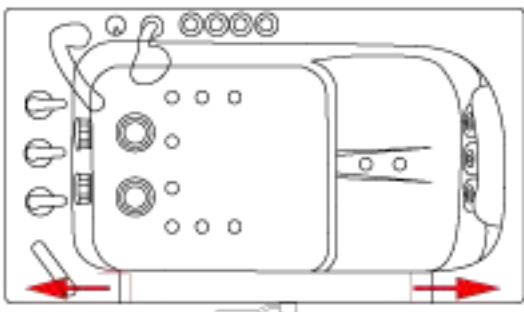
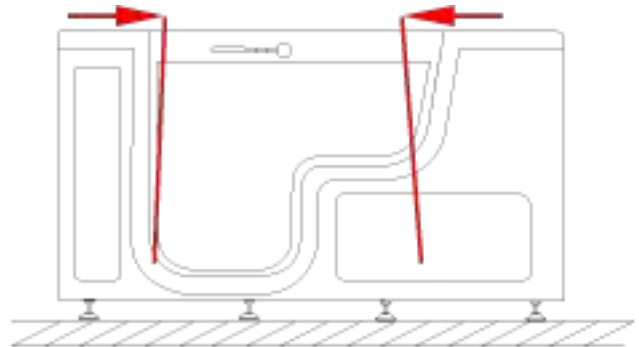
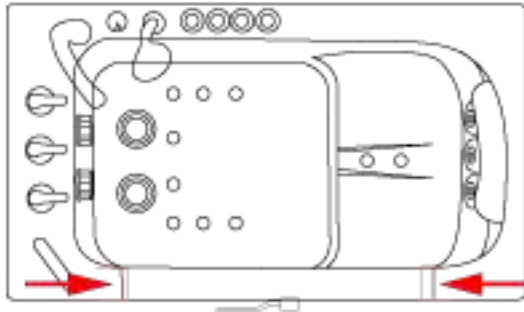

It is the responsibility of the installer or owner to provide access for service required, per code. Accessibility Professionals is not responsible for any costs related to obtaining access for repair. The owner shall assume responsibility for such costs, and if appropriate, must seek recovery from the installer.

Do not insulate around the tub equipment. The tub, frame and all parts have been engineered to provide the proper ventilation. Any obstructions may cause the pumps or other electrical components to overheat.

### Door Seal

Please keep in mind that the door has been closed for an extended period of time throughout shipping and the bathtub has been stored in various temperatures. It is possible for the silicone seal to stick to the frame when stored for extended periods of time. When the bathtub is received, the door seal should be checked for deformations from shipping and re-formed and adjusted where necessary. To restore the door seal, the seal must be released and allowed to relax with the door open. This is done by squeezing the seal with your finger tips and pulling it away from the door frame to regain its flexibility and original form. It is recommended that the door be kept open when not in use to increase the lifetime of the door seal and maintain its flexibility.



- Parts List: Chrome grab bar x  
 (1)Escutcheon x (2)  
 Rubber washers x (4)  
 Metal washers x (2)  
 Bolts x (2)

## WARNING

GRAB BAR WASHERS MUST BE INSTALLED TO PREVENT CRACKING OF THE ACRYLIC SHELL, FAILURE TO DO SO WILL VOID THE WARRANTY \*THE LARGER METAL WASHER IS THE MOST IMPORTANT OF THE WASHERS, THIS ONE ABSOLUTELY MUST BE INSTALLED TO PREVENT ACRYLIC SHELL DAMAGE

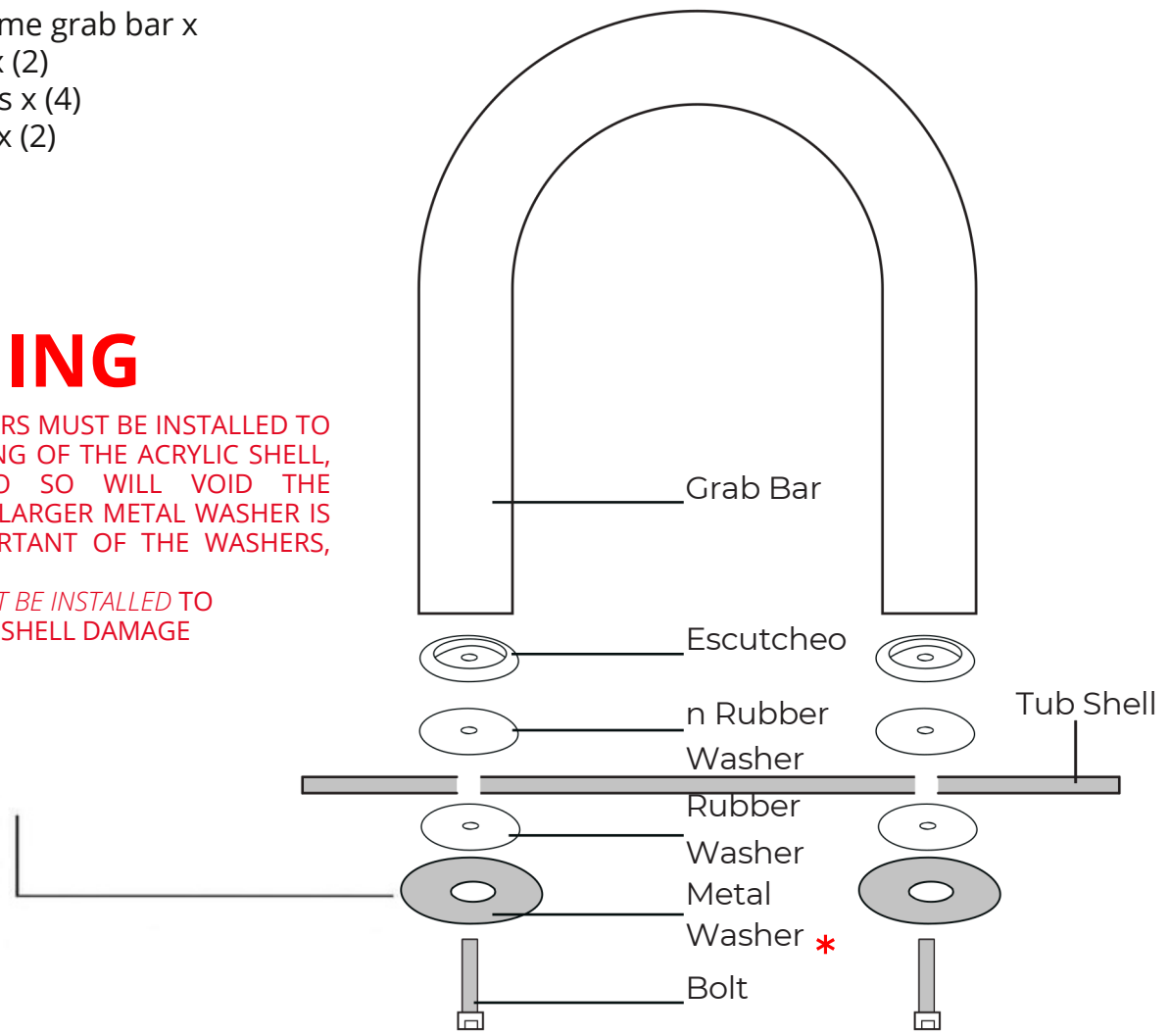

To install the supplied grab bar first locate all the parts needed for installation. See drawing shown above. Ready the bolt assembly by first placing a metal washer onto the bolt followed by a rubber washer. Feed the bolt up through the tub shell and place another rubber washer over the extruded bolt followed by the escutcheon. You may start the threading into the grab bar to hold the assembly loosely in position and then repeat the process for the second bolt. Once the entire assembly is in place, tighten the bolts with the supplied Allen wrench.

**WARNING:** Under no circumstances install the grab bar without the large metal washer underneath the tub shell. Doing so will leave the tub shell vulnerable to cracking and void the warranty.

Transfer-26  
 Transfer-30  
 Transfer-32  
 52" L x 26" W  
 52" L x 30" W  
 52" L x 32" W  
 Transfer-XXXL 55" L x 36" W

- L" Stainless Steel Brackets ...Qty (2)
- 1" x 1/8" Bolts .....Qty (7)
- 1" x 1/4" Bolts .....Qty (2)
- 1/2" Nuts .....Qty (2)
- 3/8" Nuts .....Qty (7)
- Medium Washers .....Qty (4)
- Small Washers.....Qty (14)



1. Install 3 extension support brackets provides in the kit.
2. Clamp in place, the extension panel to the walk in tub shell, lining up the facade of top and front.
3. Pre-drill (+3/8") slightly wider holes than mounting screws to allow for final adjustment to the panel.
4. Mount extension with 7 screws, washers and bolts.
5. Apply Silicone or white caulking as needed.

*The extension kit can be installed as needed. Opening can be filled as desired.*

## Finishing the Installation of the Walk-In Bathtub to the Wall

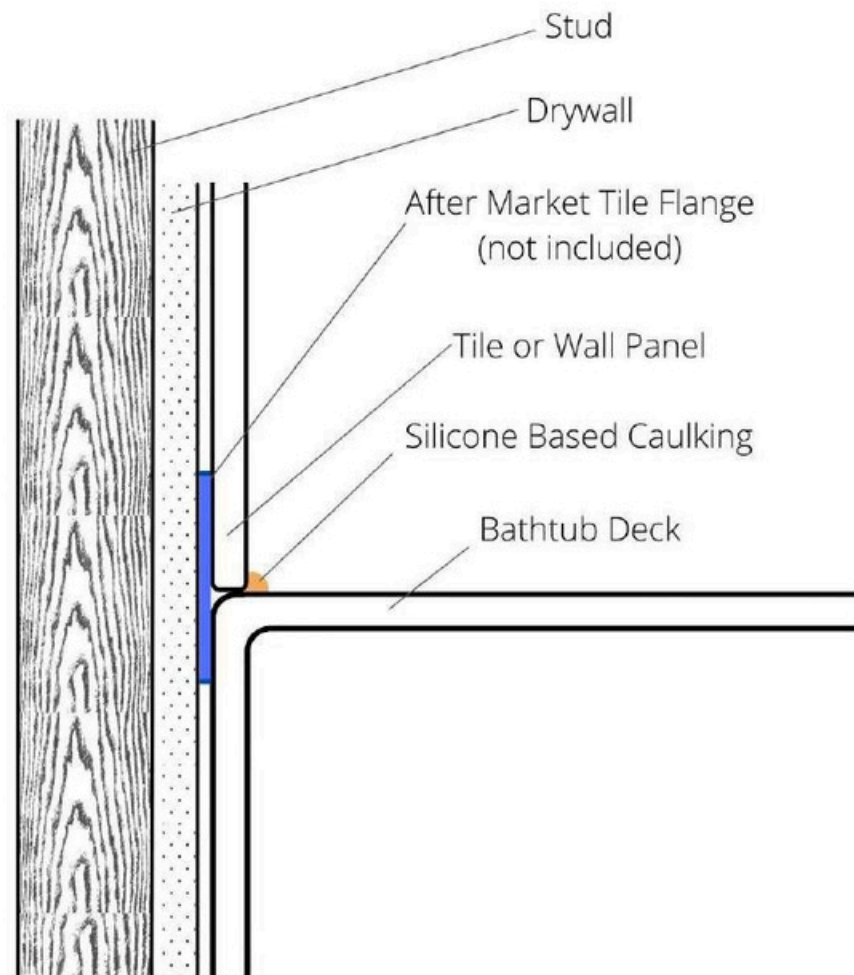

The walk-in bathtub can be installed and finished with tile or wall panel as shown in image above. The walk-in bathtub deck design is flat, allowing for tile or wall panel to overlap the tile flange and the deck for a proper seal and to have enough distance between the controls and the wall. It is suggested to install the tile flange to the edge of the bathtub with 100% silicone before pushing the walk-in tub against the wall into the place. Any thin (1/8" or 3/16") rustproof and waterproof material like acrylic, thin stainless steel, or fiberglass strip can be used as a tile flange. A tile flange can also be supplied by a contractor (available online). The strip can be approximately 5" tall, just enough to be glued to the edge of the tub and overlap the edge by 2" giving enough water barrier. Silicone-based caulking must be applied to joints.

NOTE: Any alterations or installed additions are the responsibility of the installer. Accessibility Professionals is not responsible for any damage to the unit or for water damage, which could occur due to improper installation.

## 1. Entering the walk-in bathtub:

- The L-shape inward swing door handle is located on the inside of the tub, and is designed for a safer entry with an added deck and a wall mounted grab bar.
- Once you are in the tub, remain standing and close the door. While the door may be closed from a sitting position, it is much more difficult.

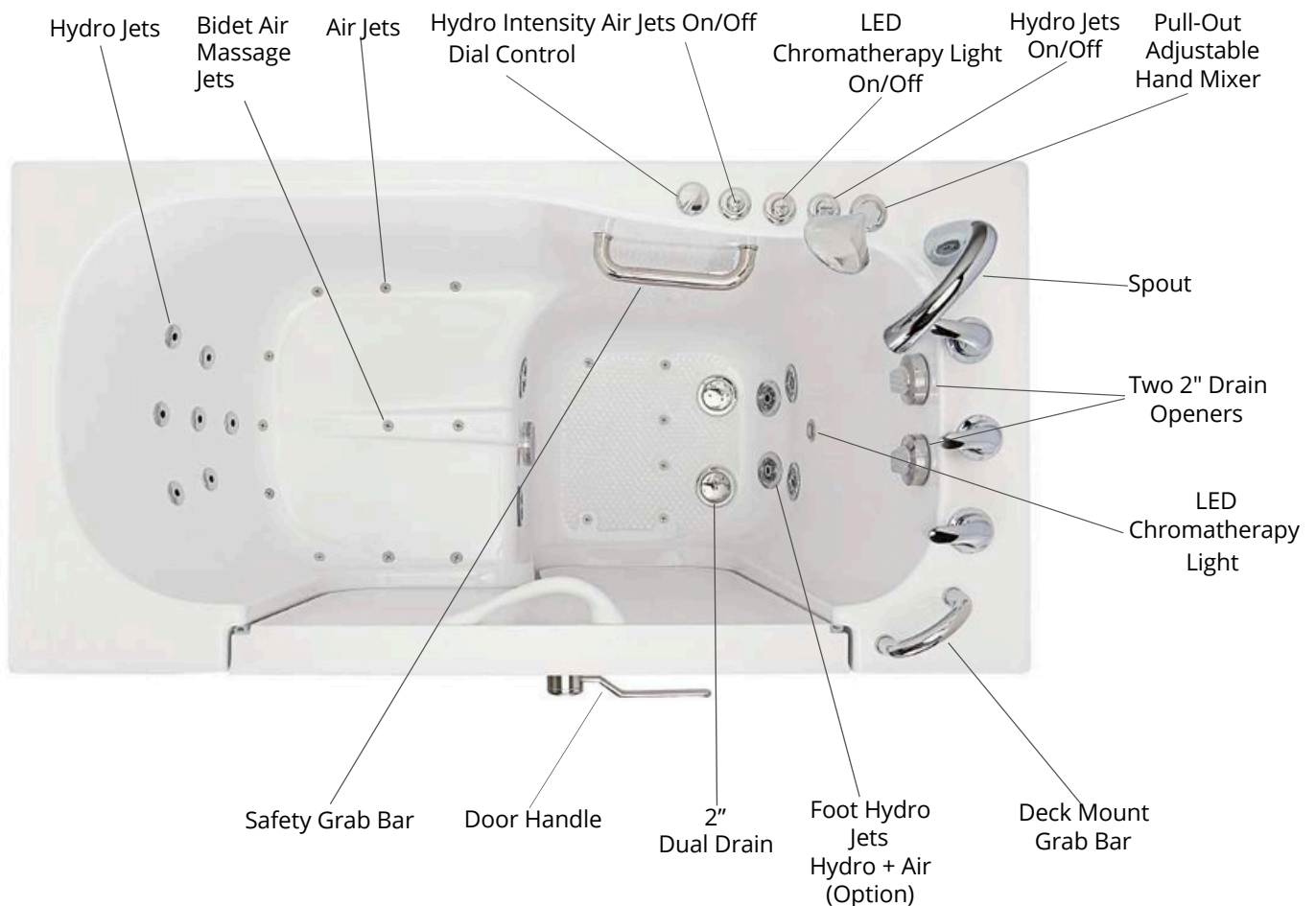

**NOTE:** L-Shape Outward-Swing Door Walk-In Bathtub with Air + Hydro Massage Option Shown Above

## 2. Filling and Draining the Tub:

- Open the drain by turning handles clockwise, and close the drain by turning counter-clockwise.
- To avoid spills or leaks, do not fill the tub over the center of the drain handle.
- Do not open the door unless the tub is completely drained!
- 



2 Drain Openers

## 3A. 2 Piece Fast-Fill Faucet:

- To turn the water on, lift the lever. The temperature can be adjusted by turning the lever to the left for hot water, and to the right for cold water.
- To switch between the faucet and hand-shower, push the diverter button located under the spout.
- To turn the faucet off, push the lever down.
- **NOTE:** The hand-shower has 5 water flow settings controlled by a dial.



## 3B. 5 Piece Fast-Fill Faucet:

- To turn the water on, turn the hot (marked red) or cold (marked blue) handle to your desired temperature.
- To turn the pull out hand-shower on, turn the diverter (middle lever) towards "OFF" and push down on the faucet lever.



**NOTE:** The hand-shower has 5 water flow settings controlled by a dial.

## 4A. Push Controls

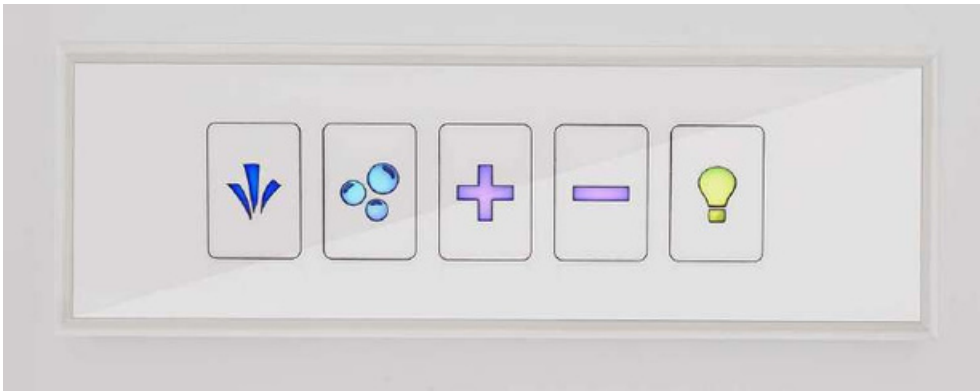
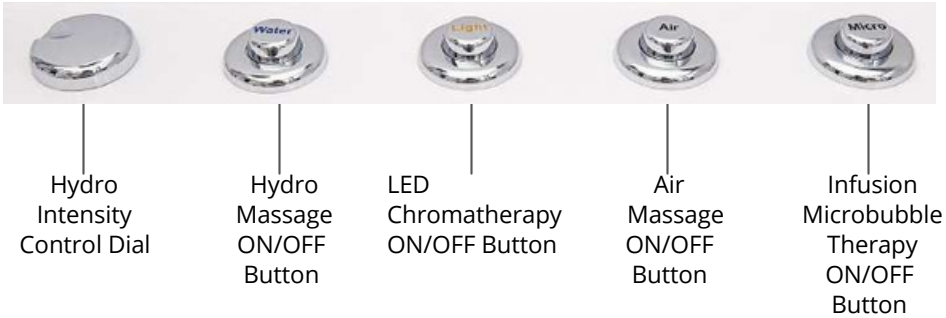

Hydro Massage ON/OFF Button

Air Massage 3 Speed Control

LED Chromotherapy ON/OFF Button



## 4C. LED Chromotherapy Light

Press the button once for a continuous stream of changing lights. To maintain a solid color (8 colors to choose from), continue to press the button until your desired light shines. To turn off, press and hold the button.

Push Control Option: Push ON/OFF control labeled "Light" to turn the light On/Off.

Digital Control Option: Push the button with the lightbulb symbol to turn the light On/Off.



LED Light Shown Below

## 5. Hydrotherapy System

### Push Control Option:

Push ON/OFF control labeled "Water" to turn the hydro pump on. To turn it off, press it again.

### Digital Control Option:

Push the digital ON/OFF control labeled with 3 water streams to turn the hydro pump on. To turn it off, press it again.

### Adjusting the Water Massage Intensity:

Turn the intensity dial control clockwise or counter-clockwise to adjust the water pressure to your liking.

### In-Line Water Heater:

The in-line water heater will automatically turn on/off when the hydro pump is turned on/off. The purpose of the in-line water heater is to maintain the temperature of the water.

### Ozone Sterilization:

The ozone sterilization will automatically turn on/off as soon as the hydro pump is turned on/off.



Hydro Jets Shown



Hydro Intensity Control Dials Shown



Fixed Upper Hydro Massage Jets (Back and Hips)

Adjustable Lower Hydro Massage Jets (Calves)

Adjustable Lower Hydro Massage Jets (Feet)



## 6. Air Therapy System

Auto-Purge Maintenance System:

Air Massage is equipped with an auto-purge feature that automatically turns on

- 20 minutes after the pump has been turned on. It runs for 120 seconds to ensure your system is clear and free of excess water, moisture, or mildew.

**WARNING:** Do not be alarmed if the system turns on while you are bathing! It will run for 120 seconds before turning off. No need to leave the tub if this happens.



Auto-Purge Shown Above

Push Control Option:

- Push ON/OFF push control button labeled "Air" to turn the air pump on. To adjust the speed, continue to press the button (one press for low, two presses for medium, and three presses for high speed). To turn it off, push the button four times.

Digital Control Option:

- Push the digital control button marked with the air bubble symbol to turn the air pump on/off. To cycle through variable speeds, use the + and - buttons.

Air Jets Shown

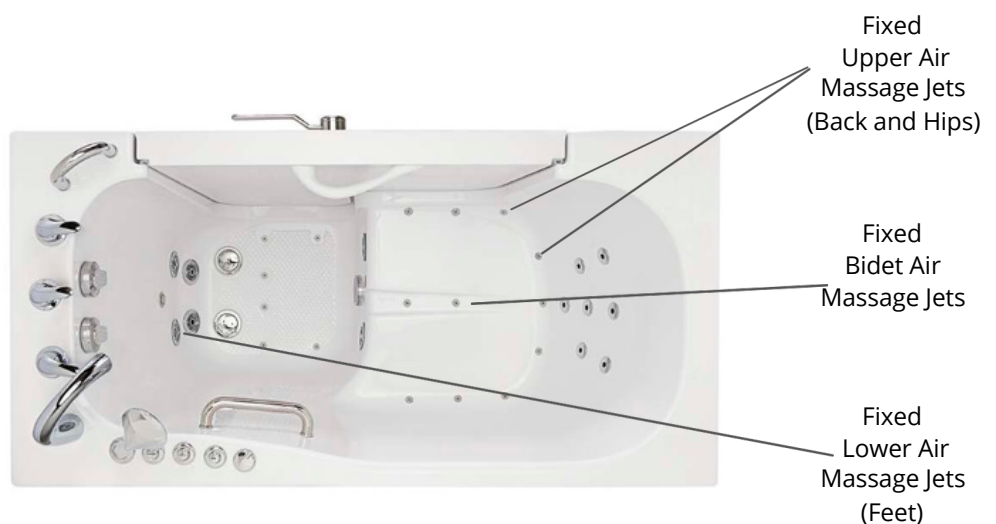

## 7. Infusion™ Microbubble Therapy

Push Control Option:

- Push ON/OFF control labeled "Micro" to turn the hydro pump on. To turn it off, press it again.



Infusion™ Microbubble Therapy  
Universal Installation Kit Shown Above



Infusion™ MicroBubble Therapy System consists of a single Microbubble jet connected to a hydro pump and Microbubble Tank System.

## 8. Heated Seat & Back

Digital push control on the front face of the tub turns the heated seat/back On/Off. Make sure to only press one, pressing the button again will turn it off.

Turn on 10-15 minutes prior to entry to allow the seat to heat up

Turns off automatically after 20 minutes



Digital Push Control Shown Above

## Features

- Uses less energy than a standard light bulb
- Flexible, strong & uniquely safe
- Energy saving, reflective foil/foam insulation
- Hermetically sealed heating elements and connections
- Made in the USA
- One-touch, individualized, comfort maintenance
- 20 minute automatic shut-off timer
- Splash resistant housing for transformer and electronics
- Attractive LED "heatwave" display



## Before First Time Use

The Pump Circulation System needs to be flushed and drained before using a Freedom Walk-in Bathtub for the first time. To flush the bathtub, combine 2 cups of white vinegar and 2 cups of water. Then, fill the bathtub with water to reach an inch above the highest jets. Add the vinegar/water mixture, and run the bathtub for 10 minutes. Since the air and hydro system are plumbed, it is not necessary to flush after each bath. To remove construction debris, use a mild detergent. More stubborn debris may be removed with denatured alcohol or Clorox Soft Scrub cleaner. Additionally, light scratches and dulled areas may be restored to their original luster by polishing the surface with a fine grade, automotive type cleaning and polishing compound, such as Turtle Wax brand products.

## Suggested Monthly Cleaning Instructions

It is recommended that the pump's inlet cover is cleaned and the pump circulation system is flushed once a month. You can clean the pump's inlet cover by clearing debris, such as hair, followed by wiping it down using a non abrasive towel and a suggested cleaning material (see below).



Inlet Cover

## Suggested Cleaning Materials

We recommend cleaning your walk-in bathtub once a month using a 1:1 ratio of white vinegar and water. Combine 2 cups of white vinegar and 2 cups of water. Then, fill the bathtub with water to reach an inch above the highest jets. Add the vinegar/water mixture, and run the bathtub for 10 minutes. You may also use the following cleaning products on your Freedom Walk-in bathtub:

- Dishwashing Detergent
- Lysol Power Bathroom Cleaner
- CLR Bath & Kitchen Cleaner
- Formula 409 All-Purpose Cleaner
- Iron Out Rust Stain Remover

## ATTENTION:

We do not recommend using abrasive cleaners and cleaning materials. Additionally, avoid using bath bombs because they may be difficult to clean or clog the jet system(s). Bath oils, fragrances and salts may be used, however these items are not suggested because it may require more frequent maintenance and cleaning of your bathtub and/or plumbing.



## Freedom Acrylic Walk In Bath Warranty Information

This limited lifetime warranty is extended to the first purchaser to be free from defects in workmanship and material under normal use and conditions from the date of the original purchase. This warranty is nontransferable and applies only to the original owner and to the original installation place – address only and does not extend to products previously used as display models or products that have been modified or repaired by anyone else but the manufacturer. The warranty is void if the ownership or original installation location is changed (tub is relocated). This warranty relates to all fittings and components included with the tub from the manufacturer. The bathtub shell, frame, door seal, and finish are covered by limited lifetime warranty. The door is covered by a limited lifetime warranty under normal use and conditions. All supporting equipment, motors, pumps, fixtures, electronic controls, faucet, waste, overflow, and all plated finishes, are covered by a limited five (5) year warranty. This warranty is nontransferable and applies only to the original owner. The finish warranty does not apply to fading, cracking, delaminating or blistering due to excessive wear, sun fading or scouring due to cleaning. This warranty shall not apply to any failure resulting from negligence, abuse, misuse, misapplication, alteration, or modification or improper maintenance. The door warranty is valid only if the alignment of the door is not changed by applying pressure or user's weight hold user's weight to the door or by wrong installation. The door is designed to hold its own weight and not designed to hold user's weight. Should service be required for any reason of any defect or malfunction of the product during the first five years, The manufacturer will ship the part to the original customer's address without charge (subject to verification of the defect or malfunction). The manufacturer will not be liable for any incidental expenses or material charges in connection with removal or replacement of the product or parts. Delivery time is based on parts availability and location. Normally parts are sent out immediately. Emailed or mailed photos of defective product and description of the problem is required. defective product and description of the problem is required.

The Manufacturer will not be responsible for any water damage to structures or property for any reason including but not limited to manufacturer defect or improper installation. Manufacturer will assume no responsibility for the loss of the system, inconvenience due to loss, damage to real or personal property or any other consequential damage. Manufacturer will not be liable for any incidental expenses or material charges in connection with removal or replacement of the purchased part or any part or parts of the system. This warranty shall not apply to any type of failure resulting from negligence, abuse, misuse, misapplication, improper installation, alteration or modification, chemical corrosion or improper maintenance. There will be a charge for replacement parts or replacement of the entire electrical unit of the defective unit is returned for any of the reasons listed above. The manufacturer reserves the sole authority to make any type of warranties or representations concerning its products and will not be responsible for any warranties or representations made by any outside source including dealers, retailers, distributors or contractors. The manufacturer does not warrant the installation of any of our products. Items include: all plumbing or electrical related connections, improper or negligent installation of the product. Alteration made of, or alterations or modifications made to the system, may cause the product or the system to malfunction. Such problems are not covered by warranty.

TO THE EXTENT PERMITTED BY LAW, ALL IMPLIED WARRANTIES INCLUDING THOSE OF MERCHANTABILITY AND FITNESS FOR A PARTICULAR PURPOSE ARE HEREBY DISCLAIMED.

The manufacturer and seller hereby disclaim any liability for special, incidental, or consequential damages. Some states/provinces do not allow limitations on how long an implied warranty lasts, or the exclusion or limitation of special, incidental or consequential damages, so these limitations and exclusions may not apply to you. This warranty gives you specific legal rights. You may have other rights, which vary from state/province to state/province.

### **Disclaimer: Limited lifetime parts warranty does not apply to thermostatic control valve (TCV).**

TCV warranty is (1) year limited warranty which does not cover cartridge malfunction due to contaminated water with calcium, iron or other found heavy particles in the water resulting in cartridge getting stuck and TCV not operating properly. The TCV must be protected with filter or mesh in the water lines which must be cleaned periodically. The manufacturer offers cleaning service for the cartridges for a nominal fee: labor + shipping. The cartridge cleaning is done at the manufacturer facility, or it can be done by the contractor hired by customer. The removal and cleaning of TCV should only be performed by a licensed and insured contractor or plumber following online instructions. Non-Manufactured faucets are not covered under this warranty. Please refer to their own original manufacturer's warranty.



## Installer's Information

\_\_\_\_\_  
Name

\_\_\_\_\_  
Address City State Zip

\_\_\_\_\_  
Telephone / Email

\_\_\_\_\_  
Date / Signature

Upon completing the installation of the Walk In Bath, the following Warranty Activation Form must be completed, signed by both the customer and installer, and returned to Accessibility Professional's. In order for the Warranty to be activated (scanned, or emailed, or hard copy mailed).

---

### To be initialed by the installer(s)

- Tub is level in all directions and all support legs are touching the ground.
- Tub is installed on a dedicated GFCI protected circuit
- Frame of the tub has been properly grounded.
- Door Seal has been cleaned with rubbing alcohol to remove any dust or debris left over from construction.
- Temperature Control Valve operated on both hot and cold settings.
- Both diverters function properly.
- Hand Shower functions on all settings without leaking.
- All supply lines have been checked for leaks while both diverters are on.
- Drains open and close properly, and the locking nut has been tightened on both stoppers.
- Door seal is water tight after tub has been filled for a minimum of 20 minutes.
- After running for a minimum of 20 Minutes both the Hydro and Air Pumps are functioning properly and all connections to the pumps and jets are water tight.
- Chromatherapy Light and the Ozone Sterilization are working properly. (When the Ozone is on by itself it will make a light humming noise).
- All drain fittings have been checked for leaks while the tub is draining.
- Unit is installed with access to both plumbing and electrical connections.



## Owner's Information

---

Name

---

Address City State Zip

---

Telephone / Email

---

Date / Signature

---

Model: \_\_\_\_\_ Serial Number: \_\_\_\_\_

Contact Name: \_\_\_\_\_ Phone Number: \_\_\_\_\_

To activate manufacturer's warranty, please complete both pages and use one of the options below to submit.

Via mail: Accessibility Pro

Warranty Department

11 Victoria St unit B3, Barrie, ON L4N 6T3

Via email: [apsupport@accessibilitypro.com](mailto:apsupport@accessibilitypro.com)